

Miele
NOVOTRONIC

Operating instructions

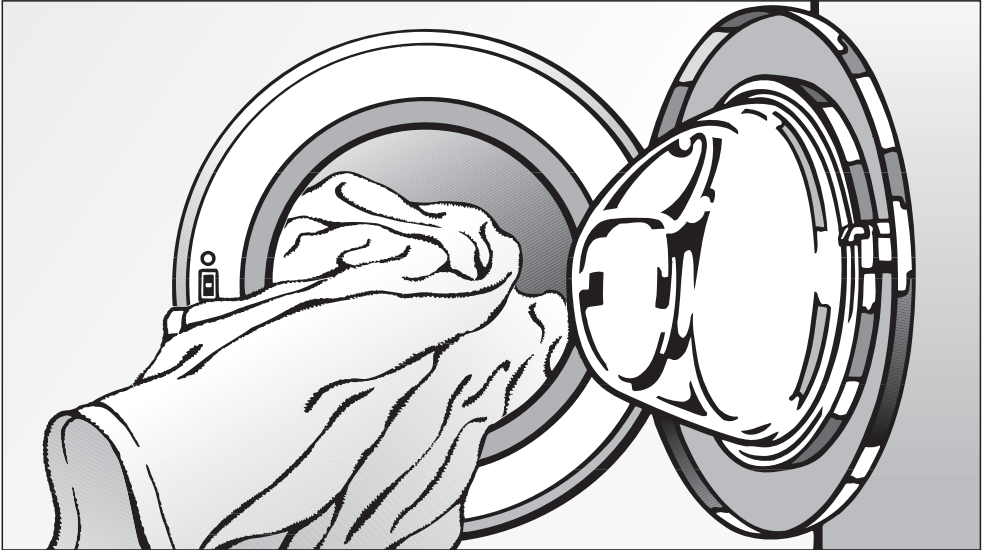

Washer W 1966

To prevent accidents and machine damage, read these instructions **before** installation or use.



M.-Nr. 05 631 101





Contents

IMPORTANT SAFETY INSTRUCTIONS	4
Quick Guide	Centre pages
Guide to the washer	5
Control panel	5
Before using the washer	6
Using the washer	7
1. Prepare and sort laundry	7
2. Load the laundry	8
3. Select a program	9
Special programs	9
Program guide	10
4. Select a spin speed	11
5. Select wash options (if needed)	12
6. Add detergent	13
Detergent	14
Water softener	14
Fabric softener	15
Starch	15
Using the "Starch" program	15
Fabric dye	15
Using the washer	16
7. Start the program	16
8. Activate the program lock (if necessary)	16
9. Unload the laundry	17
Adding/removing laundry during a wash program	18
Cancelling a program that has not yet started	18
Cancelling a program that has started	19
Making changes to the program	19
Skipping part of a program	19
To change a program	19







Locking the washer	20
Electronic program lock	20
Child Safety Lock	21
Washer care	22
Cleaning the washer	22
Cleaning the detergent drawer	22
Cleaning the drain pump and lint trap	23
Cleaning the water inlet filters	25
Cleaning the inlet hose filter	25
Cleaning the filter in the inlet valve	25
Frequently asked questions	26
The program will not start	26
The program stops and a fault indicator blinks	26
The program runs normally but a fault indicator lights up	27
Poor wash results	28
The door will not open when the "Door" button is pressed	30
Opening the drum door during a power failure	31
After Sales Service	32
PC Update	32
Installation instructions	33

IMPORTANT SAFETY INSTRUCTIONS

 **WARNING** - To reduce the risk of fire, electric shock, or injury to persons while using your appliance, follow basic safety precautions, including the following:

-  Read all instructions before using the appliance.
-  **GROUNDING INSTRUCTIONS**
This appliance must be grounded. In the event of malfunction or breakdown, grounding will reduce the risk of electric shock by providing a path of least resistance for electric current. This appliance is equipped with a cord having an equipment-grounding conductor and a grounding plug. The plug must be plugged into an appropriate outlet that is properly installed and grounded in accordance with all local codes and ordinances.
-  **WARNING** - Improper connection of the equipment-grounding conductor can result in a risk of electric shock. Check with a qualified electrician or serviceman if you are in doubt as to whether the appliance is properly grounded.
-  Do not modify the plug provided with the appliance - if it will not fit the outlet, have a proper outlet installed by a qualified electrician.
-  Do not wash articles that have been previously cleaned in, washed in, soaked in, or spotted with gasoline, dry-cleaning solvents, or other flammable or explosive substances, as they give off vapors that could ignite or explode. Do not add gasoline, dry cleaning solvents, or other

flammable or explosive substances to the wash water. These substances give off vapors that could ignite or explode.

-  Under certain conditions, hydrogen gas may be produced in a hot water system that has not been used for 2 weeks or more. **HYDROGEN GAS IS EXPLOSIVE**. If the hot water system has not been used for such a period, before using the washing machine, turn on all hot water faucets and let the water flow from each for several minutes. This will release any built up hydrogen gas. As the gas is flammable, do not smoke or use an open flame during this time.
-  Do not allow children to play on or in the appliance. Close supervision is necessary when the appliance is used near children.
-  Before the appliance is removed from service or discarded, remove the door.
-  Do not reach into the appliance if the drum is moving.
-  Do not install or store this appliance where it will be exposed to the weather.
-  Do not tamper with the controls.
-  Do not repair or replace any part of the appliance, or attempt any servicing unless specifically recommended in these Operating Instructions.

SAVE THESE INSTRUCTIONS

Control panel

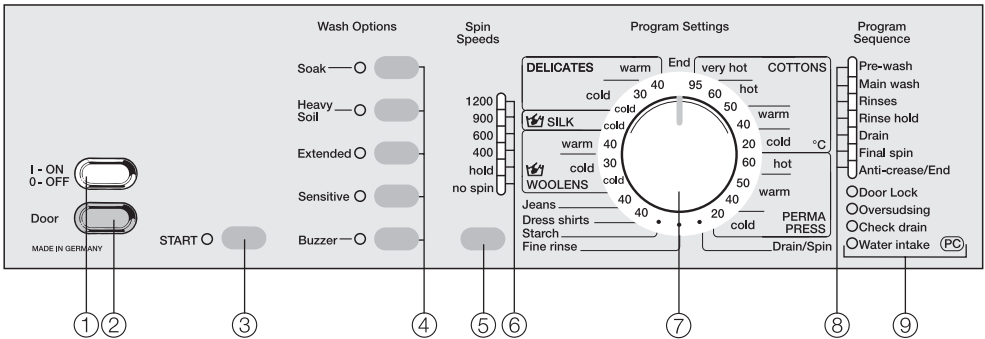

1 "On/Off" button

turns the machine on and off or interrupts a program.

2 "Door" button

opens the drum door.

3 "START" button

begins the wash program.

4 Wash options

are special wash features available to enhance a wash program.

5 Spin speed selector button

allows you to select the final spin speed of a program.

6 Spin speed indicator light

7 Program selector

for selecting a program and wash temperature.

The light ring will go out a few minutes after the end of the program to save energy.

8 Program sequence display

shows the current cycle of the wash program.

9 Fault indicators

Before using the washer

The appliance must be correctly installed and connected before the first use. Please see the "Installation instructions."

Before using the washer, a program must be run without laundry and without detergent to flush out any residual water from the factory testing process.

- Close washer door.
- Press in the "On/Off" button.
- Turn the program selector to "COTTONS/very hot".
- Press the "Spin" button until the "900" mark of the indicator lights.
- Press the "START" button.

Once the program ends the washer can be used for laundry.

1. Prepare and sort laundry

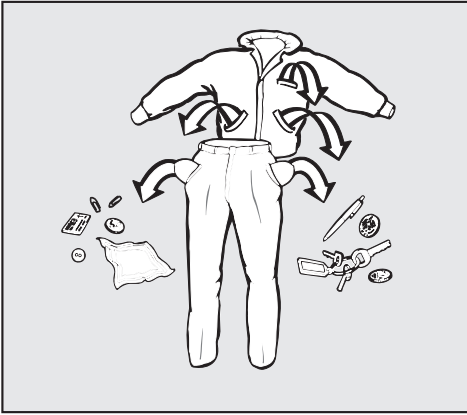

■ Empty all pockets.

 Foreign objects left in pockets (e.g. nails, coins, paper clips, etc.) can cause damage to clothes and the machine.

■ Sort the laundry.

Only wash items that are labeled machine washable by the manufacturer. Most garments have a fabric care label in the collar or side seam. Sort the laundry by care label and color.

■ Pretreat stains.

Tough stains (blood, egg, coffee, tea etc.) or badly soiled areas (collars and cuffs) should be pretreated with a stain remover or a paste made from powder detergent and warm water.

- Dark fabrics often "bleed" the first few times they are washed. They should be washed separately several times before being included in a mixed load.
- Remove any lead weights or strips from curtains before washing.
- Loose bra underwires should be removed or sewn in place before washing.
- Woolens and knitted garments should be turned inside out.
- Close zippers, hooks and eyelets before washing.

Using the washer

2. Load the laundry

- Turn on the washer using the "On/Off" button.
- Open the drum door using the "Door" button.
- Load the laundry into the drum.
For best results, wash mixed loads of small and large items. This will improve washing effectiveness and help distribute the load evenly.

Note: Overloading the washer will affect wash results and cause wrinkling.

- Close the drum door.

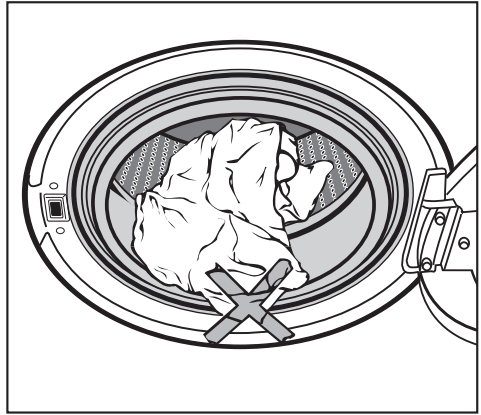

To prevent damage to the door seal and clothing, make sure that there are no clothes caught between the drum door and the seal.

3. Select a program

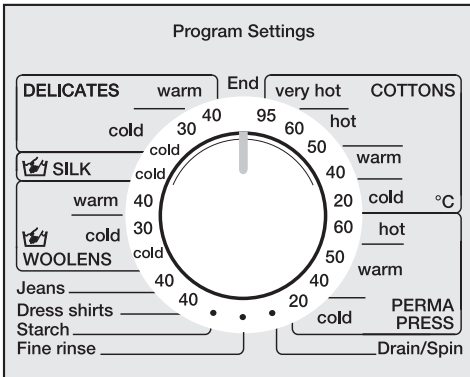

- Turn the program selector in either direction to the program you wish to use.

Special programs

SILK

Gentle program for hand and machine washable silk fabrics. Cool water and slower wash, rinse, and spin cycles reduce wrinkling and fading.

WOOLENS

Specialty care program for hand and machine washable wool and wool blends. A mild range of wash temperatures, low water level and minimum drum movement gently clean and maintain the shape of garments.

Jeans

Specially designed program that washes denim materials at the correct temperature to release stains and at a spin speed that prevents wrinkles.

Dress shirts

Program for cleaning dress shirts with reduced wrinkling.

Fine rinse































Laundry is only rinsed and spun in this program.

Starch

This program is for starching without washing. See "Detergent/ Using the "Starch" program" for details.

Using the washer

Program guide

Temperature	Care symbols	Fabric		
Cottons Available wash options: Soak, Heavy soil, Extended, Sensitive				
95 °C / very hot		–	white household linens	100 % cotton sheets, cloth diapers, towels, etc. to be sanitized. Not for use with clothing with elastic.
60 °C / hot		–	sturdy white cottons	Underwear, cotton t-shirts, socks.
50 °C / hot			light colors	Colorfast items.
40 °C / warm			bright colors	
20 °C / cold			dark colors	Black items, mixed loads.
PERMA PRESS Available wash options: Soak, Heavy soil, Extended, Sensitive				
60 °C / hot		–	whites	For cotton blends, easy-care cottons, wrinkle-free items. Polyester blends and synthetics such as acrylic, nylon, ramie. Fabric softener can be dispensed in the final rinse of these programs to reduce static cling.
50 °C / warm			light colors	
40 °C / warm			bright colors	
20 °C / cold			dark colors & temperature sensitive fabrics	Spandex, microfibers, etc.
Drain / Spin No available wash options				
DELICATES Available wash options: Soak, Heavy soil, Extended				
40 °C / warm			light colors	For synthetics, machine washable silks, satin, hosiery, lingerie, lace or crocheted (non-wool) items, curtains and knits.
30 °C / cold			dark colors	
cold / cold		–	lace or sheer fabrics, embroidered items.	
SILK No available wash options				
● / cold			silk and silk blends, lingerie and hosiery	Ideal for machine and hand washable silks and other non-wool handwashable garments
WOOLENS No available wash options				
40 °C / warm			light colors	For hand washable and machine washable wool and wool blends (e.g. lamb's wool, chashmere, mohair, angora, etc.)
30 °C / cold			dark colors	
cold / cold	–	–	delicate woollens	
Jeans No available wash options				
40 °C			denim	
Dress shirts Available wash options: Soak, Heavy soil, Extended				
40 °C				
Starch No available wash options				
Fine rinse No available wash options				

4. Select a spin speed

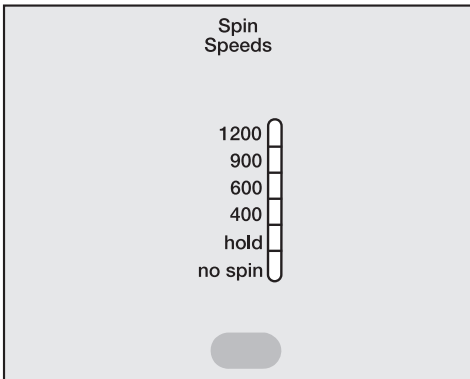

The default spin speed will automatically be selected for each program. However, you can adjust the spin speed within the parameters listed below.

- Press the "Spin" button until the indicator for the desired spin speed lights.

Available spin speeds	Program
1200 to 900	COTTONS
1200 to no spin	WOOLENS, Jeans, Starch, Fine rinse, Drain/Spin
900 to no spin	PERMA PRESS, Dress shirts
600 to no spin	DELICATES
400 to no spin	Silk

Special spin options

– Hold

Laundry is not spun and remains soaking in water. This will prevent wrinkles if the laundry is not removed immediately at the end of the wash program. When ready, select a spin speed to continue the program. To finish the program: Press the "Door" button.

– No spin

The laundry is not spun after the final rinse but the water is drained away. After the drain cycle the washer goes immediately into the anti-crease cycle. Spinning between the rinses is also omitted in this setting.

This option is not available in the "COTTONS" program.

Using the washer

5. Select wash options (if needed)

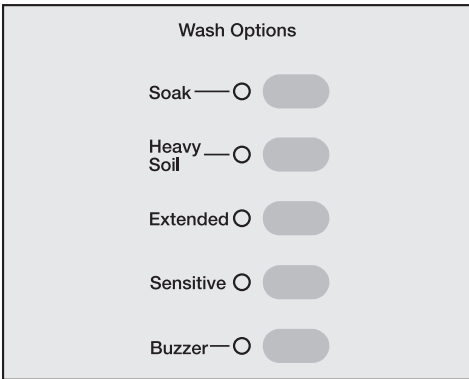

- Press the button for the wash options you would like to select. The indicator light for the respective option will illuminate.

If a wash option is chosen and it is not compatible with the program, the indicator light will go out when the button is released.

Soak

For heavy soiling and stubborn stains (e.g. blood, grease, cocoa), that require soaking before the main wash.

Each press of the "Soak" button will add 30 minutes (6 hours max) of soak time to the wash program.

Heavy soil

For heavy soiled laundry where a pre-treatment is necessary to remove surface soiling.

Extended

For laundry with stubborn or old stains. The longer wash time works to relax fabrics and release stains.

The total time for the wash program will be extended.

Sensitive

An additional final rinse will wash away detergent residue and scents for the sensitive skin and nose.

Buzzer

A buzzer can be selected to signal the end of the wash program.

The buzzer will sound until the washer is turned off.

6. Add detergent

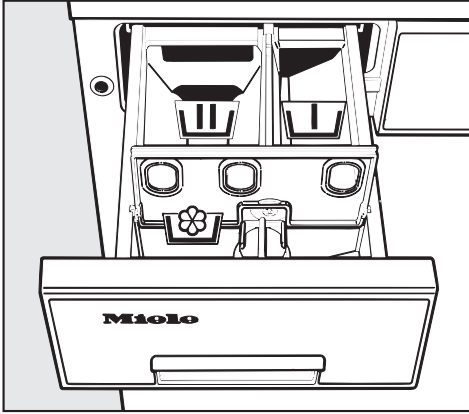

⚠ Do not use detergents containing chemical solvents.

- Pull out the detergent dispenser drawer and add detergent to the compartments.

U = Detergent for the main wash

U = Only add detergent ($\frac{1}{4}$ of the total recommended amount of detergent) to this compartment if the heavy soil wash option is selected.

⊗ = Fabric softener or liquid starch.



- Close the detergent dispenser drawer.

Detergent

Only use high efficiency, low sudsing laundry detergent formulated for front loading washing machines.

For wool and wool blend fabrics use a detergent formulated for wools.

Follow instructions on the detergent packaging for the correct use and amount of detergent. Please adjust the amount of detergent if the load is smaller or more or less soiled than normal.

Add detergent to compartment  at the beginning of each wash program. Only add detergent ($\frac{1}{4}$ total recommended amount) to compartment  if the "Heavy soil" option was selected.

If you select the "Heavy soil" option and you are using liquid detergent, insert the liquid detergent insert into compartment . This will prevent the detergent for the main wash being used in the first wash of the "Heavy soil" option.

Do not use chlorine bleach!

Water hardness

Hardness level	Water quality	Water hardness ppm
1	soft	0 - 130
2	middle	130 - 250
3	hard to very hard	over 250

Water softener

If your water hardness level is between 2 and 3 the water can be softened to reduce detergent consumption.

Use the recommended amount of detergent for water hardness level 1 and then add a water softener to the detergent dispenser.

Fabric softener

Fabric softener added to the wash program will make fabrics feel softer and will reduce static cling in the dryer.

- Open the lid of compartment ☼.

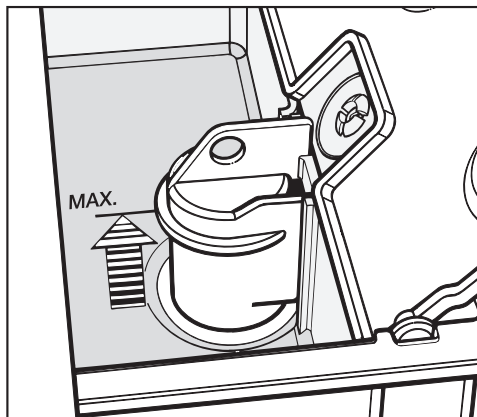

- Pour the amount of liquid fabric softener into compartment ☼ according to the manufacturer's instructions. Do not exceed the maximum fill level marked inside the compartment, as the excess will prematurely activate the siphon and be wasted.
- Close the compartment lid and push in the dispenser drawer.

The softener will automatically be dispensed during the final rinse cycle. A small amount of water will remain in the ☼ compartment at the end of the program.

Never mix fabric softener and starch in compartment ☼. This will clog the dispenser.

Starch

Starching can be included in any wash program as part of the final rinse or can be performed separately.

- Open compartment ☼.
- Add the recommended amount of starch to compartment ☼.
- Close the compartment lid and push in the dispenser drawer.
- The starch will be dispensed during the final rinse.

Using the "Starch" program

- Add the amount of starch recommended on the packaging to compartment ☼.
- Turn the program selector to "Starch".
- Select a spin speed.
- Press the "START" button.

If starching frequently, clean the dispenser compartment and especially the siphon tube and fabric softener duct. See "Cleaning the detergent dispenser drawer".

Fabric dye

- Do not use fabric dyes in this washer.

Using the washer

7. Start the program

- Press "START" to begin the program.

8. Activate the program lock (if necessary)

- Hold the "START" button until the "Door Lock" indicator lights up.

See "Locking the washer" for further details.

9. Unload the laundry

- Open the drum door by pressing the "Door" button.

Do not attempt to remove laundry from the washer if the drum is turning. You may seriously injure yourself. If the drum turns with the door open, contact Miele's Technical Service Department.

- Remove the laundry.

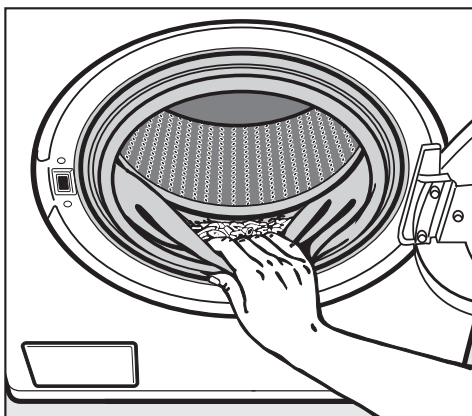

- Check the folds of the door seal for any small articles which may have been trapped.

Check the drum for any missed pieces of laundry. Items inadvertently left in the washer may be damaged (e.g. shrink) or discolored during the next wash cycle.

- Turn off the washer using the "On/Off" button and turn the program selector to "End".

- Close the drum door.

Otherwise foreign objects may find their way into the drum. These could be inadvertently washed and cause damage to laundry.

- Turn off the water valve.

Using the washer

Adding/removing laundry during a wash program

You can interrupt the following programs to add or remove a piece of laundry:

- COTTONS
- PERMA PRESS
- Jeans
- Dress Shirts
- Starch
- Press the "Door" button and open the drum door.
- Add or remove the piece of laundry.
- Close the door.

The program will automatically continue.

The drum door can not be opened if:

- the water temperature is greater than 55 °C.
- the water level is too high.
- the child safety lock is activated.
- the program has reached the final spin cycle.

If you press the "Door" button during any of these conditions the "Door Lock" indicator will light.

Cancelling a program that has not yet started

- Turn the program selector to "End" for a few seconds.
- Turn the program selector to the new program.

Cancelling a program that has started

- Turn off the washer with the "On/Off" button.
- Turn the program selector to "End".
- Turn on the washer with the "On/Off" button.
- Turn the program selector to "Drain/Spin".
- Select the desired spin speed.
- Press "Start".

Making changes to the program

The following changes can be made to a program once it has already started:

- the spin speed may always be adjusted.
- up to 6 minutes after the start of a program the wash options "Sensitive" and "Extended" can be selected or deselected and the temperature of the program can be changed to another temperature within the same program.

Once the program starts you can not change to a different program.

The "Anti-crease/End" indicator will blink if the program selector has been moved. The program will not be affected. The indicator will go out, if the program selector is turned back to the original program.

Skipping part of a program

- Turn the program selector to "End".

When the desired program cycle flashes in the program sequence display:

- Turn the program selector, within 4 seconds, back to the original program.

To change a program

- Turn off the washer using the "On/Off" button.
- Turn the program selector to "End".
- Turn on the washer using the "On/Off" button.
- Select the new program.
- Select the desired spin speed.
- Press the "START" button.

Locking the washer

Electronic program lock

The program lock prevents the washer from being opened or the program being changed during a wash program.

To activate the program lock

- Once the wash program has started, hold the "START" button until the "Door Lock" indicator illuminates.

The program lock is now activated.

The washer can now no longer accept program changes and will continue to the end of the program.

At the end of the program the lock is automatically unlocked.

To cancel the program lock

- Hold the "START" button until the "Door Lock" indicator goes out.

Exception:

The program selector was moved and the "Anti-crease/End" indicator blinks in the program sequence display.

- Turn the program selector back to the originally selected program. The "Anti-crease/End" indicator light goes out.
- Press the "START" button until the "Door Lock" indicator goes out.

Child Safety Lock

This safety lock can be activated to prevent a child climbing inside the washer.

When the child safety lock is activated the drum door cannot be opened and a program cannot be started.

To activate the safety lock

Before activating the lock:

- the drum door must be closed,
 - the program selector must be at "End".
- 1.** Turn on the washer using the "On/Off" button.
 - 2.** Press the "Heavy Soil" button and hold the button pressed in during steps **3.** to **5.**
 - 3.** Turn the program selector slowly step by step clockwise to "COTTONS/ 60 °C".
 - 4.** Turn the program selector slowly step by step counterclockwise to "End" and stop.

- 5.** Then turn the program selector slowly step by step counterclockwise to the "DELICATES/cold" position. The "Door Lock" indicator (lower right of control panel) flashes.
- 6.** Release the "Heavy Soil" button.
- 7.** Turn the program selector to "End".
- 8.** Turn off the washer using the "On/Off" button.

To deactivate the safety lock

Repeat steps **1.** through **6.** The "Door Lock" indicator goes out.

Washer care

 Before cleaning the appliance, disconnect the power supply by unplugging the unit or manually "tripping" the circuit breaker.

Cleaning the washer

- Clean the exterior of the washer with a mild solution of non-abrasive detergent or soap and water, and wipe dry with a soft cloth.
- Clean the drum with a stainless steel cleaner specially formulated for use in a washer, available from Miele's Technical Service Department part # 00 077 927.

Cleaning the detergent drawer

Detergent residue should be cleaned out regularly.

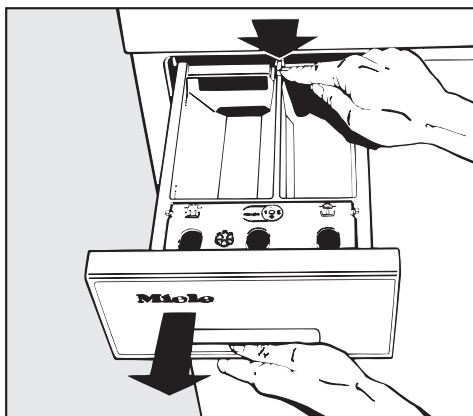

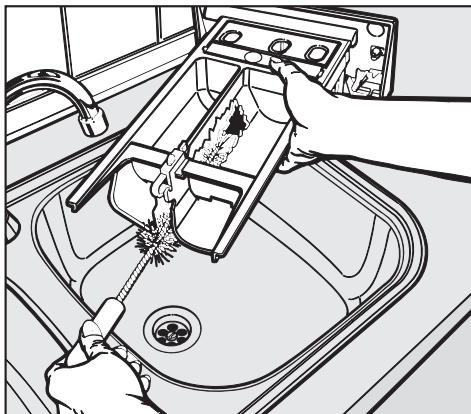

- Pull out the detergent drawer until it stops. Press down on the red release lever and pull the drawer out of the machine.

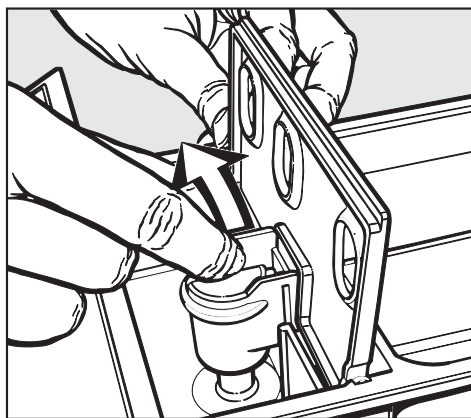

- Clean the dispenser compartments and the fabric softener duct.



- Remove the siphon tube from the compartment  and rinse under warm water.

 Do not use chemical solvents, abrasive cleaners, glass or all purpose cleaners! These can damage plastic surfaces and other parts. Do not use a hose to clean off the washer.

Cleaning the drain pump and lint trap

Occasionally small objects (buttons, coins, etc.), may find their way into the lint trap. If the machine does not drain completely, the lint trap should be checked to ensure that it is free of foreign objects.

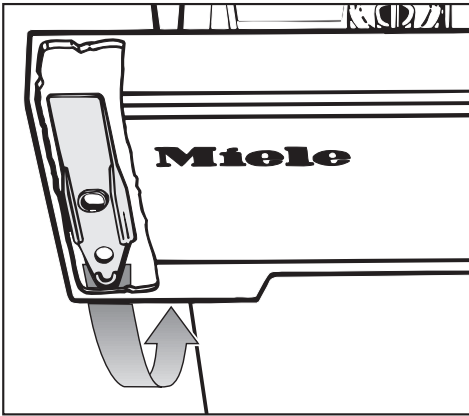

- To clean the lint trap, remove the tool from behind the detergent dispenser drawer.

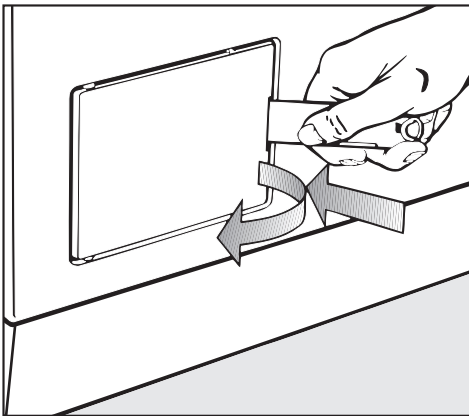

- Open the lint trap door.

- Place a 2 quart capacity container underneath the drain tube.

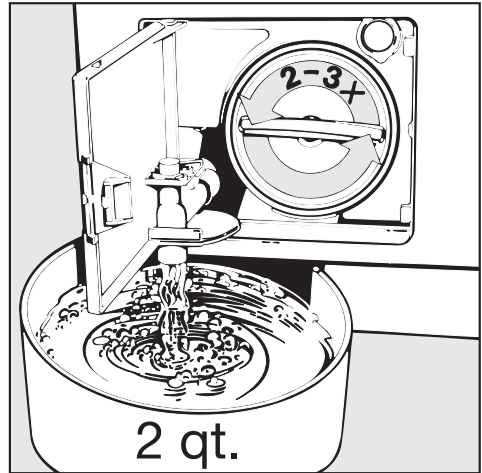

- Turn the lint trap lid counterclockwise 2 - 3 times. Do **not** remove it. About 2 quarts of water will drain out of the hose.

If the main drain hose is clogged, more water will be retained in the machine (**max. 6.5 gal**). In this case, tighten the lint trap lid and empty the container before repeating the procedure as often as necessary.

 **Caution:** If the laundry has been washed at a high temperature, the water draining out of the machine will still be hot! Stop and allow it to cool before proceeding.

Washer care

Once the flow of water stops:

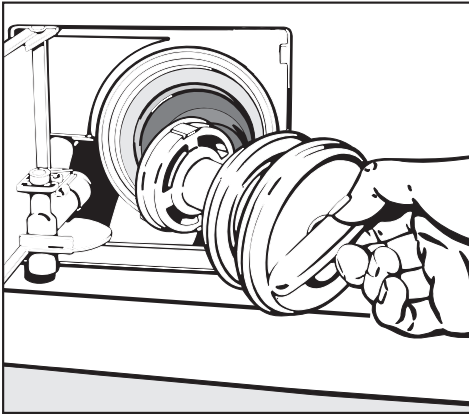

- Remove the lint trap lid.
- Clean out any foreign objects or lint from the filter.
- Check that the drain pump impeller (in the back of the chamber) rotates freely by spinning with your hand.

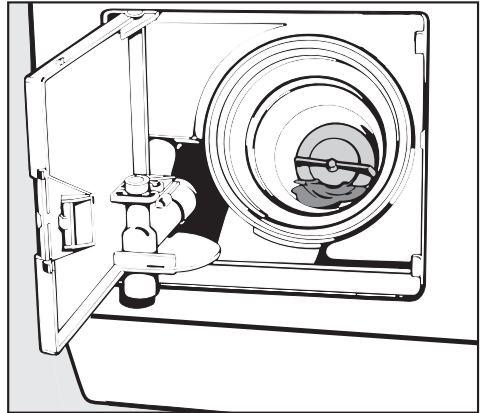

- Clean the inside of the lint trap housing. Remove any detergent deposits or foreign objects from the threads of the filter housing and filter unit before returning the lint trap.
- Return the lint trap and tighten into place.

 If the lint trap is not tightened securely water will leak out when the machine is used.

After cleaning:

- Run the "Fine rinse" program.

This step is necessary to activate the ball valve.

Quick Guide

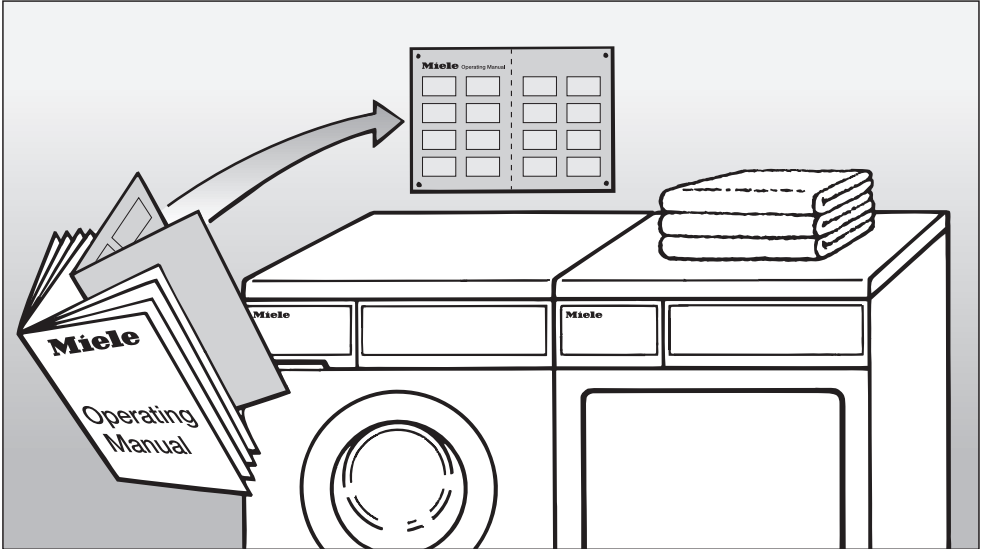

Remove this guide for easy reference

Please read all instructions, especially the "Important Safety Instructions", **before** using the washer.

Quick Guide

1. Prepare and sort the laundry

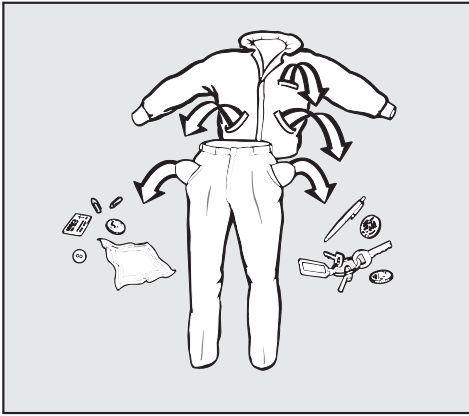

- Empty pockets.
- Sort laundry by fabric and color.
- Pretreat stains.

2. Load the laundry



- Turn on the washer using the "On/Off" button.



- Open the drum door using the "Door" button.
- Load the laundry.
- Close the drum door.
Make sure clothes will not be caught by the door.

3. Select a program

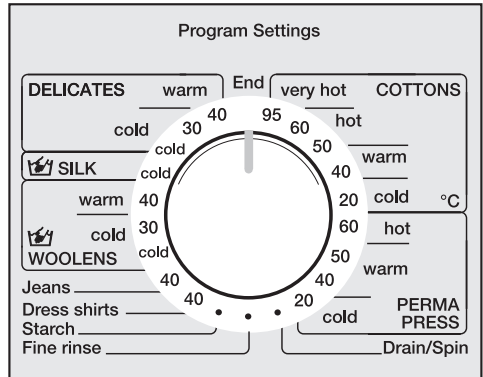

Check the program guide, to determine which program is best for the load being washed.

4. Select the spin speed

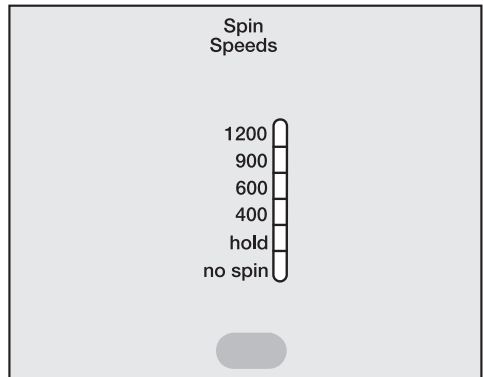



5. Select wash options (if needed)

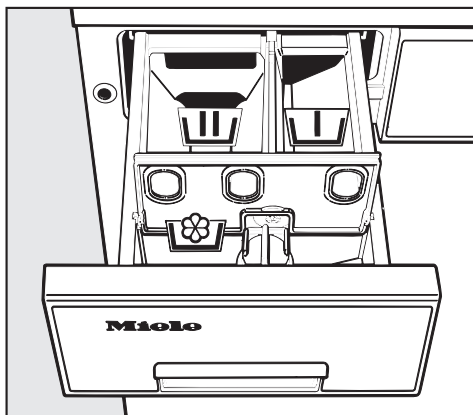

6. Add detergent



-  = Detergent for the main wash
-  = Only add detergent ($\frac{1}{4}$ of the total recommended amount of detergent) to this compartment if the heavy soil wash option is selected.
-  = Fabric softener or liquid starch.

7. Start the program

8. Activate the program lock (if necessary)



- Hold the "START" button until the "Door Lock" indicator lights up.

9. Unload the laundry

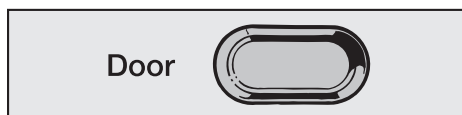































- Open the drum door using the "Door" button.
- Remove the laundry.



- Turn off the washer using the "On/Off" button and turn the program selector to "End".
- Close the drum door.

Quick Guide

Program guide

Temperature	Care symbols	Fabric		
Cottons Available wash options: Soak, Heavy soil, Extended, Sensitive				
95 °C / very hot		–	white household linens	100 % cotton sheets, cloth diapers, towels, etc. to be sanitized. Not for use with clothing with elastic.
60 °C / hot		–	sturdy white cottons	Underwear, cotton t-shirts, socks.
50 °C / hot			light colors	Colorfast items.
40 °C / warm			bright colors	
20 °C / cold			dark colors	Black items, mixed loads.
PERMA PRESS Available wash options: Soak, Heavy soil, Extended, Sensitive				
60 °C / hot		–	whites	For cotton blends, easy-care cottons, wrinkle-free items. Polyester blends and synthetics such as acrylic, nylon, ramie. Fabric softener can be dispensed in the final rinse of these programs to reduce static cling.
50 °C / warm			light colors	
40 °C / warm			bright colors	
20 °C / cold			dark colors & temperature sensitive fabrics	Spandex, microfibers, etc.
Drain / Spin No available wash options				
DELICATES Available wash options: Soak, Heavy soil, Extended				
40 °C / warm			light colors	For synthetics, machine washable silks, satin, hosiery, lingerie, lace or crocheted (non-wool) items, curtains and knits.
30 °C / cold			dark colors	
cold / cold		–	lace or sheer fabrics, embroidered items.	
SILK No available wash options				
● / cold			silk and silk blends, lingerie and hosiery	Ideal for machine and hand washable silks and other non-wool handwashable garments
WOOLENS No available wash options				
40 °C / warm			light colors	For hand washable and machine washable wool and wool blends (e.g. lamb's wool, chashmere, mohair, angora, etc.)
30 °C / cold			dark colors	
cold / cold	–	–	delicate woollens	
Jeans No available wash options				
40 °C			denim	
Dress shirts Available wash options: Soak, Heavy soil, Extended				
40 °C				
Starch No available wash options				
Fine rinse No available wash options				

Cleaning the water inlet filters

The washer has two water inlet filters to protect each inlet valve. These filters should be checked and cleaned if necessary every 6 months. This may have to be done more frequently with some water supplies.

Cleaning the inlet hose filter

- Turn off the water valve.
- Unscrew the inlet hose from the valve by turning the connector counter-clockwise using a wrench if necessary.

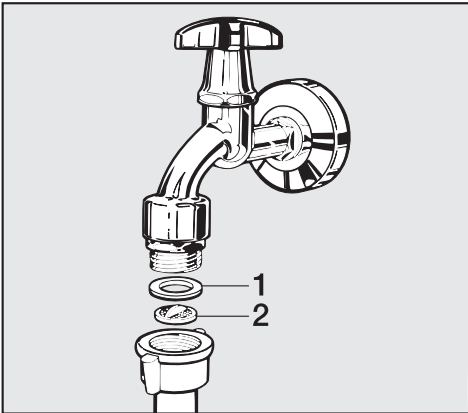

- Remove the rubber seal, **1**, from the connector.
- Using needle nose pliers, grasp the plastic filter, **2**, and pull it out of the hose connector.

- Clean the filter under running water and carefully remove any large particles. Replace the filter and seal and reconnect the hose.
- Slowly turn on the valve and check for leaks.

⚠ Inspect the hose regularly. The hose must be in good condition to withstand high water pressure. The hose should be replaced if there are small cracks in the surface, or if it has been otherwise damaged or cut.

Cleaning the filter in the inlet valve

- Using a wrench, carefully loosen and remove the plastic hose connector on the inlet valve.

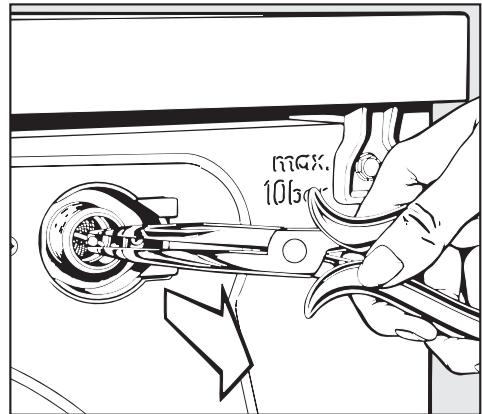

- Using needle nose pliers, withdraw the plastic filter by pulling on the bar (see illustration). Rinse under water and return parts.

Both filters **must** be put back in place after cleaning.

Frequently asked questions

With the following guide, minor problems can be fixed without a service call.

The program will not start.		
What if ...	Possible cause	Fix
the program indicator "Anti-crease/End" does not light, or the START button does not blink?	The washer has no power.	Check whether: <ul style="list-style-type: none"> – it is plugged in. – if the circuit breaker has tripped.
the "Door Lock" indicator blinks?	The lock function is activated.	Deactivate the lock function.
The program stops and a fault indicator blinks.		
What if ...	Possible cause	Fix *
the fault indicator "Check drain" blinks?	The drain is blocked.	Clean the lint trap and the drain pump.
	The drain hose is too high.	The maximum drain pump height is 3 ft (1m).
the fault indicator "Water intake" blinks?	The water inlet is blocked.	Open the water valve.
	The inlet hose filter is clogged.	Clean the filter under running water and carefully remove any large particles.
the "Soak", "Heavy soil" or "Sensitive" indicators blink?	There is a fault.	Start the program one more time. If the fault message appears again call Miele's Technical Service Department.

* To turn off the fault indicator light: Turn off the washer with the "On/Off" button and turn the program selector to "End".

Frequently asked questions

The program runs normally but a fault indicator lights up.		
What if ...	Possible cause	Fix *
the "Check drain" indicator blinks?	The drain is blocked.	Clean the lint trap and the drain pump.
the "Water intake" indicator blinks?	The water intake is impaired.	Check whether: <ul style="list-style-type: none"> – the water valve is open. – the inlet hose is kinked.
	The inlet hose filter is dirty.	Clean the filter under running water and carefully remove any large particles.
the "Oversudsing" indicator lights?	The machine has oversudsed.	Run a drain cycle. Only use the recommended amount of a high efficiency detergent.
the "Main Wash" indicator blinks in the program sequence display?	There is a fault.	Start the program once more. If the fault message appears again call Miele's Technical Service Department.
the "Anti-crease/End" indicator blinks in the program sequence display?	The program selector was moved to a different setting after the program started.	Turn the program selector to the original position.

* To turn off the fault indicator light: Turn off the washer with the "On/Off" button and turn the program selector to "End".

Frequently asked questions

Poor wash results.		
What if ...	Possible cause	Fix
the washer shakes during the spin cycle?	The washer's feet are not resting evenly on the floor.	Level the machine (see Installation Instructions.)
	The shipping struts have not been removed.	Remove the shipping struts.
the wash is too wet after the final spin?	The spin speed was too low.	Next time select a higher spin speed.
there are unusual sounds coming from the drain pump?	There is no fault.	Lapping sounds at the beginning and end of the pump process are normal.
the light ring does not light?	The washer has turned off the light ring to conserve energy.	To turn the light ring back on, press a wash option button or turn the program selector.
detergent residue remains in the dispenser drawer?	The water pressure is too low.	<ul style="list-style-type: none"> – Clean the water intake hose filter under running water and carefully remove any large particles. – Select the "Sensitive" wash option with the next load.
	Detergent used with a water softener tends to become sticky.	Add detergent to the dispenser before adding a water softener.
the fabric softener is not completely dispensed or too much water remains in the compartment? 	The siphon tube is either incorrectly positioned or clogged.	Clean the siphon tube, see "Washer care / Cleaning the detergent dispenser drawer".
	The dispenser drawer was not pushed in when the fabric softener was being dispensed.	Make sure the drawer is in all the way.

Frequently asked questions

What if ...	Possible cause	Fix
the laundry has a gray sticky residue?	Not enough detergent was used to dissolve greasy deposits in heavily soiled laundry.	<ul style="list-style-type: none">– Add more detergent.– Before washing more laundry run an empty load on "COTTONS/60°C" with detergent to clean out the machine.
there is white detergent residue on dark laundry?	The detergent was not completely dissolved because of hard water.	<ul style="list-style-type: none">– Before drying, remove white residue with a brush for clothes.– In the future, add a water softener to the detergent.

Frequently asked questions

The door will not open when the "Door" button is pressed.

Fault	Fix
The washer is not hooked up to electricity.	Insert the plug into the outlet.
The washer is not turned on.	Turn on the washer using the "On/Off" button.
The child safety lock is activated.	Deactivate the child safety lock as described in "Locking the washer."
The electronic lock function is activated.	Deactivate the electronic safety lock as described in "Locking the washer."
The door was not closed correctly.	Push on the drum door and at the same time press the "Door" button.
There is still water in the drum and the washer can not drain it out.	Clean the lint trap and the drain pump. See "Washer care".
The "hold" spin speed was selected.	Select a spin speed to continue the program. Once the program ends you will be able to open the door.
The "no spin" speed was selected.	Turn the program selector to "Drain/Spin". Select a spin speed and press "START". Once the program ends you will be able to open the door.
To protect from scalding the drum door can not be opened if the wash water temperature is over 55°C.	

Frequently asked questions

Opening the drum door during a power failure

- Open the detergent dispenser drawer.

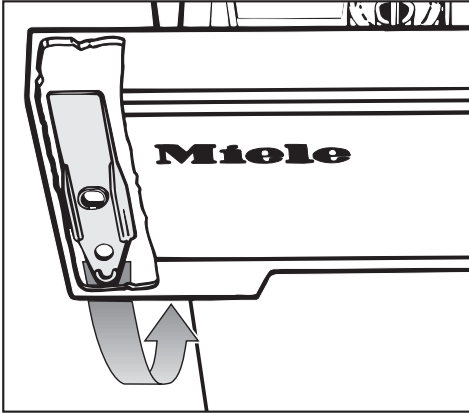

- Remove the tool.

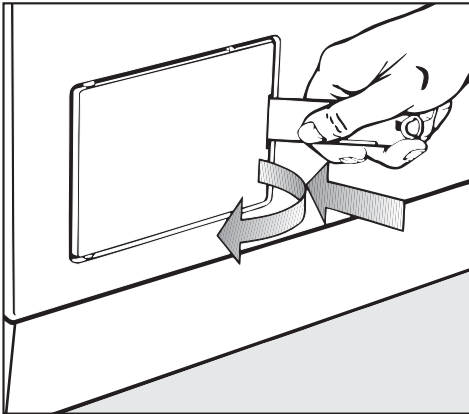

- Open the lint trap door.

- Drain the water from the washer as described in "Washer care / Cleaning the drain pump and lint trap."

⚠ Make sure the machine is off and the drum has stopped turning. A moving drum is dangerous.

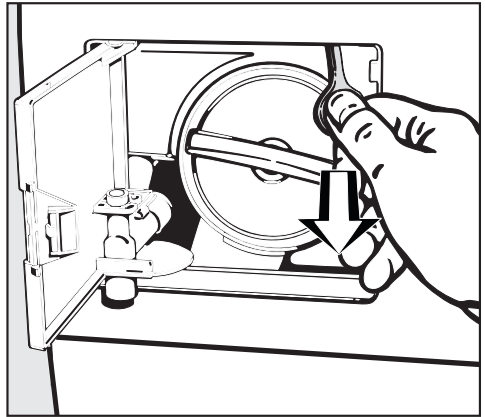

- To open the door, pull down on the ring in the upper right corner of the access area.

After Sales Service

In the event of any fault which you cannot fix yourself, please contact:

– Your Miele Dealer

or

– The Miele Technical Service Department

USA 1-800-999-1360
techserv@mieleusa.com

CDN 1-800-565-6435
service@miele.ca

When contacting the Technical Service Department, please quote the model and serial number of your appliance. Both can be found on the data plate visible above the front glass on the inside of the door.

PC Update

The indicator marked PC allows a service technician to update your machine's wash programs if new programs are developed or new fabrics are introduced.

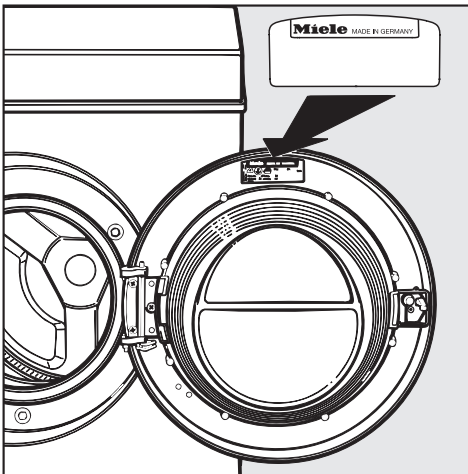

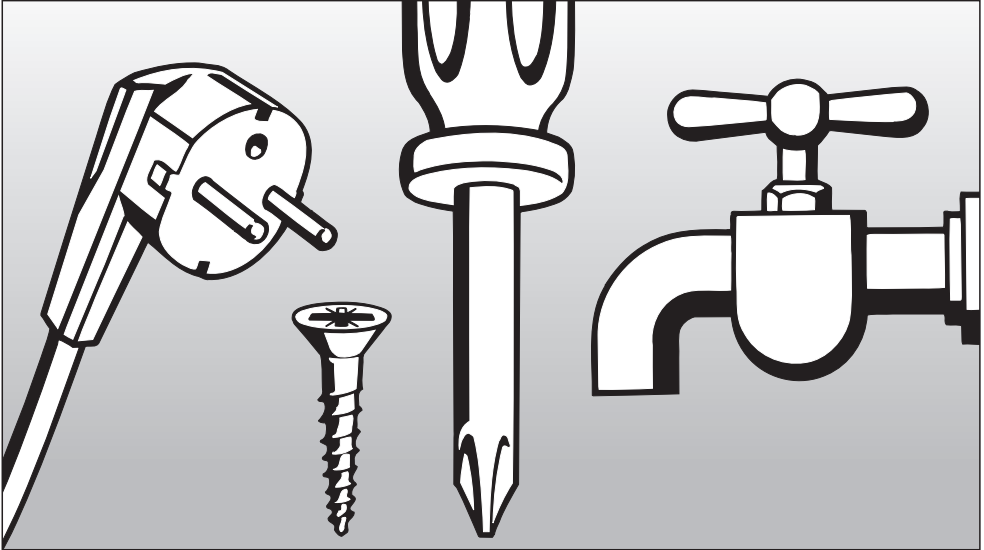

INSTALLATION INSTRUCTIONS

To prevent accidents
and machine damage
read these instructions
before installation or use.

Contents

Help protect our environment	35
Disposal of the packing materials	35
Disposal of an old appliance	35
Installation	36
Front view	36
Installation site	37
Washer / Dryer Stack	38
Installation	39
Remove the shipping struts	39
Level the washer	41
Adjust the four leveling feet	41
Plumbing connection	42
Water connection	42
Connection to the drain system	44
Electrical connection	45

Disposal of the packing materials

The cardboard box and packing materials protect the appliance during shipping. They have been designed to be biodegradable and recyclable.

Ensure that any plastic wrappings, bags etc. are disposed of safely and kept out of the reach of children. Danger of suffocation! Please recycle.

Disposal of an old appliance

Old appliances may contain materials that can be recycled. Please contact your local recycling authority about the possibility of recycling these materials.

Ensure that the appliance presents no danger to children while being stored for disposal. Before discarding an old appliance, unplug it from the outlet and cut off its power cord and remove any doors to prevent hazards.

Installation

Front view

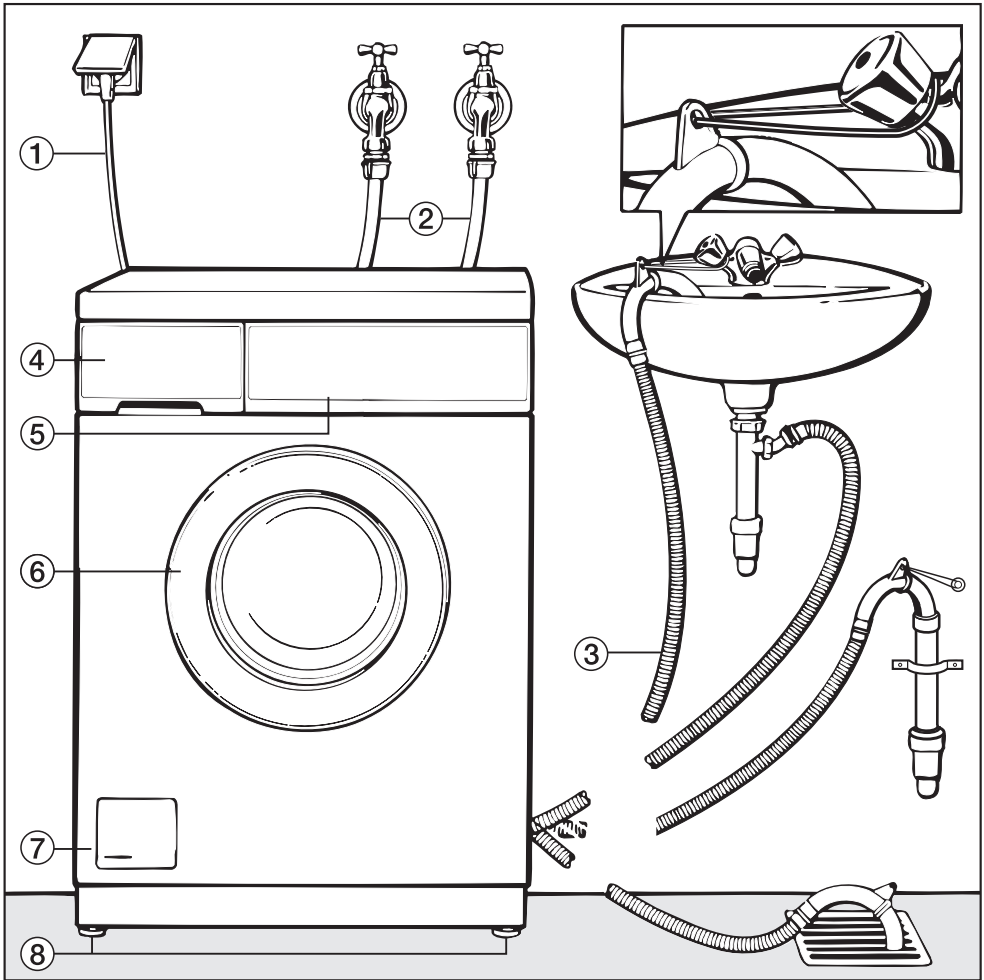

- ① Power cord
- ② High pressure intake hoses
blue mark for cold water
red mark for hot water
- ③ Flexible drain hose with detachable
swivel elbow (drain options shown)
- ④ Detergent dispenser drawer
- ⑤ Control panel
- ⑥ Drum door
- ⑦ Access panel to lint trap and drain
pump
- ⑧ Four height adjustable feet

Installation site

Horizontal access washers should be installed on the ground floor or basement of the construction for best results.

A concrete floor is the most suitable surface for the washer. Concrete floors are less prone to vibration during the spin cycle than wooden floors.

The corner of a room where the stability of the floor is at its greatest is the best place to install the washer.

Note:

- The machine must be levelled and securely positioned.
- To avoid vibration while spinning, the machine should not be installed on soft floor coverings.

If the installation must be on a wooden joist floor:

- Install the unit on a 1 1/4" thick, 23 5/8" x 23 5/8" wide plywood base. Ideally the base should be large enough to span several joists and should be anchored to the joists and not just the floor boards.

 If the machine is installed on a raised platform it must be secured with retaining clips available from your dealer or the Miele Technical Service Department.

If installed on a masonry or concrete base, the base should have a 1/2" to 3/4" high rim. This must be done to prevent the washer from vibrating off the stand during the spin cycle.

Installation

Installation beneath a counter

If a countertop is placed over the washer, at least a $\frac{1}{4}$ " gap must be left between the top of the machine and bottom of the countertop; and nothing should be within $\frac{1}{2}$ " of any other side of the washing machine.

Washer / Dryer Stack

This Miele washing machine can be installed as part of a washer dryer stack in combination with a Miele tumble dryer. The dryer can only be stacked on top of the washer and never vice versa.

The stacking kit, part # 12 996 026, is available from the Miele Technical Service Department or your Miele dealer.

A washer and dryer should never be stacked without using the proper stacking kit. Doing so is extremely dangerous, as the dryer may vibrate off of the washing machine during use.

Installation

- Lift the machine from its shipping pallet and move it to the installation site.
- Do not lift the washer by the drum door.
- Ensure that the machine's feet and the floor are dry to prevent slippage during the spin cycle.

Remove the shipping struts

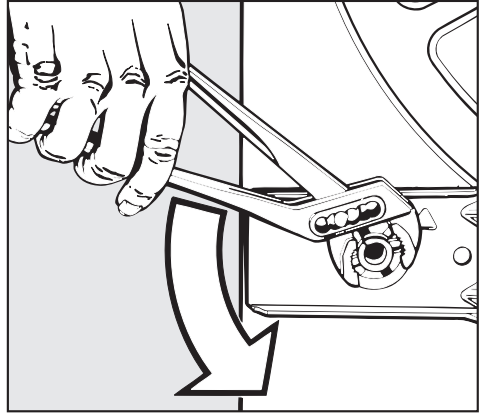

- Turn the left shipping strut counter-clockwise 90°.

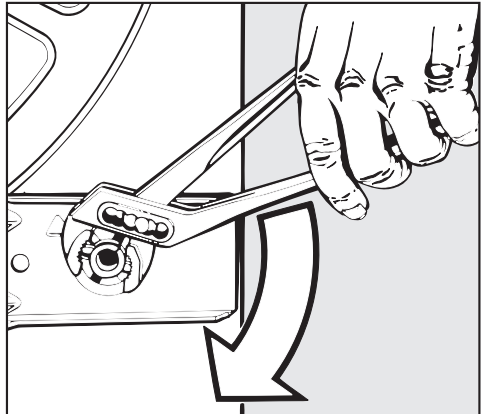

- Turn the right shipping strut clockwise 90°.

Installation

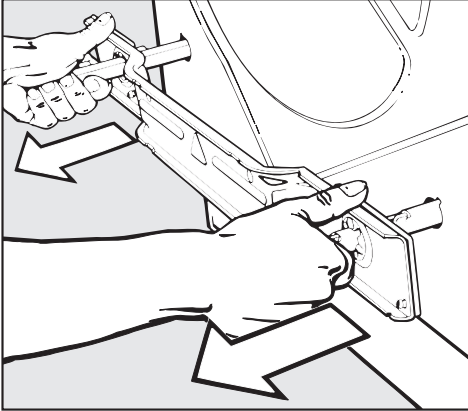

- Withdraw the two struts together with the support plate.

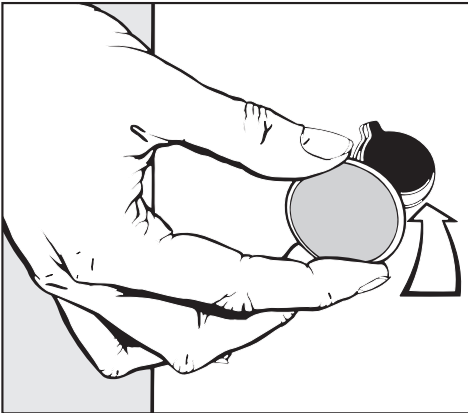

- Plug the two holes with the plastic caps provided.

 Movement of the washer without the shipping struts in place should be kept to a minimum. The struts must be reinstalled before the machine is moved. The shipping struts should be stored in a safe place for future use.

- Reinstall the struts by reversing the above procedure.

Level the washer

To ensure smooth operation the washer must be level.

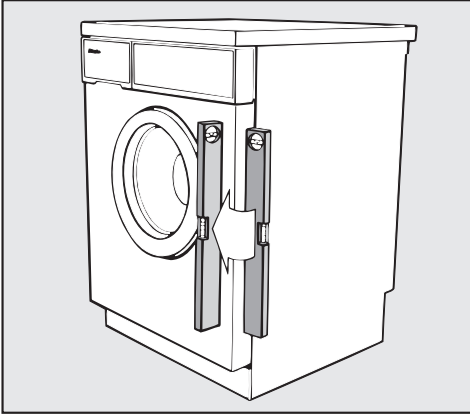

Failure to level the machine can result in increased water and energy consumption as well as the washer "banging" in the spin cycle or "walking" across the floor during use.

Adjust the four leveling feet

The washer is levelled by adjusting the four feet.

- Tip the machine slightly and place a support, such as a block of wood, underneath it.

⚠ CAUTION: The washer is heavier than it looks! When tipping the machine be careful that it does not slip. Take care not to injure yourself or damage any surrounding furniture.

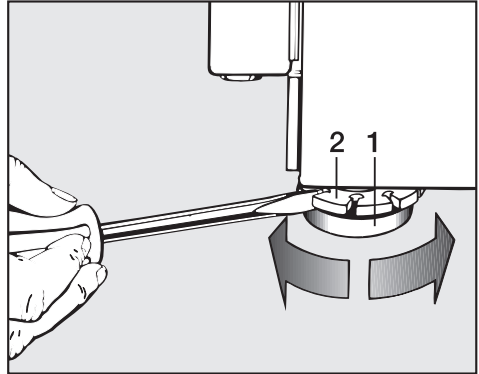

- Unscrew each of the four feet as much as necessary by turning both the foot, **1**, as well as the locking ring, **2**, to the left using a screwdriver.
- Remove the support and stand the machine on its feet.
- Check that the machine stands level.
- Repeat this procedure until the machine stands level.
- Once level, hold the foot, **1**, immobile with a wrench. At the same time turn the locking ring, **2**, to the right using a screwdriver.

⚠ All four locking rings must be tight against the bottom of the machine. In addition, check to see that the feet were not inadvertently unscrewed while tightening the rings. Running a machine that is not level or whose feet are not tight may cause damage to both the machine and its surrounding area.

Plumbing connection

Water connection

Connect the cold water intake hose (blue mark) to the cold water valve and the hot water intake hose (red mark) to the hot water valve.

If the machine is being connected to a cold water supply **only**, both the hot and cold water intake hoses must be attached to the cold water valve through the use of a Y adapter (available at a hardware store). Both hoses **must** be connected to a water source, or the machine will not function properly. **Do not** connect the washer to hot water only.

Turn on the valve(s) and check for leaks. The water pressure must be within 15-145 psi (1-10 bar). If the water pressure is greater than 145 psi (10 bar), a pressure reducer must be installed. If the water pressure is below 15 psi (1 bar), there will not be enough water available for a complete fill.

The water intake hoses are equipped with screen filters. Please do not remove these filters except for cleaning.

Tips for a hot water connection

- The hot water temperature from the hot water valve must not exceed 60°C, the ideal temperature is 55°C.
- If there is **no** water pressure at the hot water inlet, the unit automatically switches to cold water after several minutes.

Plumbing connection

The washing machine can be connected to a potable water supply. A non-return valve is not required unless required by building code.

The washing machine has $\frac{1}{2}$ " pressure hoses with $\frac{3}{4}$ " female hose thread connections.

If there is no water hookup contact a plumber to install a connection.

Make sure that the sealing ring is seated properly on the hose connector.

Only replace the hose with a genuine Miele hose or with a hose able to withstand up to 145 psi (10 bar) pressure. The water valve connector must also be able to withstand 145 psi (10 bar).

To protect the inlet valve, the two filters - one at the pressure hose / valve connection and one at the inlet connection to the solenoid valve - must be in place during use.

Plumbing connection

Connection to the drain system

The 5 ft. drain hose may be connected as follows:

- 1. Directly into a sink:** hook the hose over the edge of the sink and secure it firmly (e.g. by tying the hose to the water faucet.)
 - 2. To a stand pipe:** place the drain hose into a 1 1/2" stand pipe and firmly secure it.
 - 3. To a floor drain:** The machine is equipped with an airgap/anti-siphoning system so that no minimum drain height is required.
- The machine drains using a pump with a maximum delivery height of 3 ft.
 - Make sure there are no kinks in the drain hose.
 - If desired, the drain hose may be extended to run 16 ft maximum as long as the 3 ft height is not exceeded. Hose extensions are available from your dealer or Miele's Technical Service Department.

GROUNDING INSTRUCTIONS

This appliance must be grounded. In the event of malfunction or breakdown, grounding will reduce the risk of electric shock by providing a path of least resistance for electric current. This appliance is equipped with a cord having an equipment-grounding conductor and a grounding plug. The plug must be plugged into an appropriate outlet that is properly installed and grounded in accordance with all local codes and ordinances.

WARNING – Improper connection of the equipment-grounding conductor can result in a risk of electric shock. Check with a qualified electrician or service representative or personnel if you are in doubt as to whether the appliance is properly grounded.

Do not modify the plug provided with the appliance: if it will not fit the outlet, have a proper outlet installed by a qualified electrician.

ELECTRICAL INSTRUCTIONS

This installation should be done by an experienced and qualified technician, in accordance with local codes and regulations.

The washing machine is supplied with a 5' 3" long, 4 wire cord, ending in a NEMA 14-30 P plug, ready for connection to a 120/208-240 V, 15 A, 60 Hz, AC power supply.

The proper outlet can be purchased from an electrical supply dealer or from the Miele Technical Service Dept. Ask for a NEMA 14-30 R receptacle.

"EASY INSTALLATION KIT"

If you don't have a dedicated 4 wire, 120/208-240 V, 15 Amp line for this appliance, but you have a 240 V, 30 Amp line, you can use an optional "Easy Installation Kit", which will allow you to connect this appliance to that line.

This dual receptacle, wall mounted connection box can **ONLY** be used for connecting a Miele 1900 series clothes washer and 1500 series clothes dryer to an existing 30 Amp (NEMA 10-30R) outlet.

For more information on the "Easy Installation Kit" or if you have questions concerning the electrical connection please contact:

USA 1-800-999-1360
techserv@mieleusa.com

CDN 1-800-565-6435
service@miele.ca



Miele Limited

Canadian Head Office

55G East Beaver Creek Road

Richmond Hill

Ontario L4B 1E5

Phone: 905-707-1171

Toll-Free: 1-800-565-6435

Fax: 905-707-0177

Internet: www.miele.ca

E-Mail: info@miele.ca (general enquiries)

E-Mail: service@miele.ca (technical service)

BC Regional Sales Office

3731 North Fraser Way

Unit 200

Burnaby

British Columbia V5J 5J2

Phone: 604-434-1300

Fax: 604-434-1309

Quebec Regional Sales Office

400 Laurier Avenue West

Suite 600

Montreal

Quebec H2V 2K7

Phone: 514-277-1818

Toll-Free: 1-877-636-4353

Fax: 514-277-1838